

PA2KOL Braccio parallelo

Il braccio parallelo PA2 è realizzato per neutralizzare la reazione generata dagli avvitatori al momento del loro arresto alla coppia prefissata

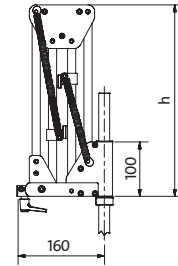

Codice	Capacità di carico	Coppia massima	Lunghezza max	Lunghezza min	Height
010600	0-2 kg	20 Nm	640 mm	440 mm	350 mm

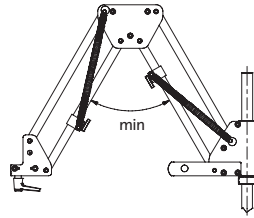
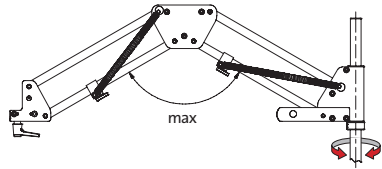
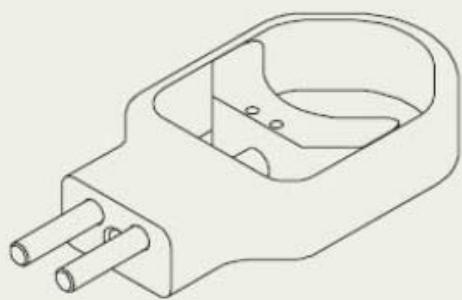

Pinza

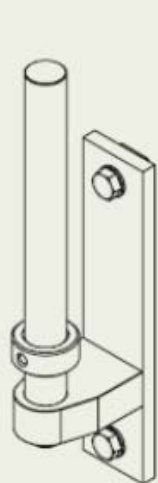
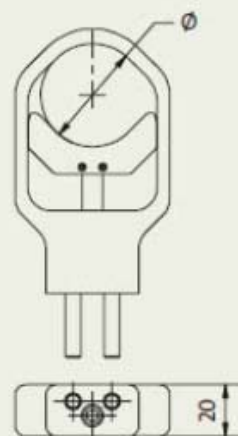

Supporto da parete

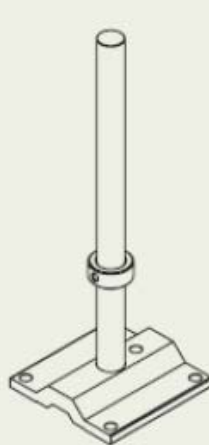
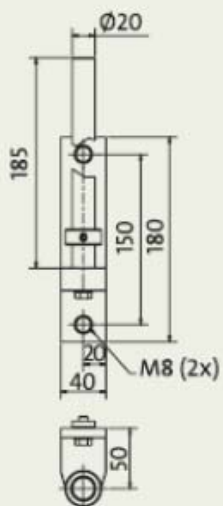

Supporto da tavolo (standard)

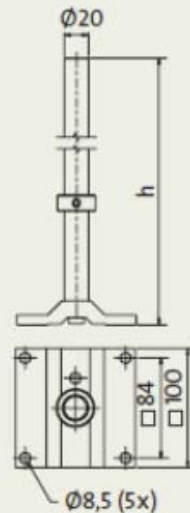

Si raccomanda di non superare un angolo di 120° ,
come mostrato nella

